

Remote Controller

User's Manual

Revision 1.02E

Photron

- The copyright of this manual is held by Photron LIMITED.
- Product specifications and manual contents can change without advanced notification.
- This manual was created taking every possible measure to ensure the accuracy of its contents. However, if you find a section which is unclear, a mistake, or an omission, please contact Photron LIMITED using the contact information provided at the end of the manual.
- Photron LIMITED is not responsible for the aftermath of the results of using the product or from following the instructions in this manual.

Introduction

Thank you for your purchase of the Photron high-speed camera accessory, the **"Remote Controller"**.

This manual contains the operating instructions and warnings necessary for using the remote controller.





Please read the entire manual before using it.

If any part of this manual is unclear, contact Photron using the contact information printed at the back of the manual.

After you finish reading the manual, store it in a safe place along with the warranty card and refer back to it when necessary.

Manual Notation

The following icons and symbols are used in the explanations in this manual.

Icon/symbol	Explanation
	This symbol indicates content that should always be read.
	This symbol indicates instructions to follow in the operation of the camera and items to be careful of.
	This symbol indicates items to be aware of when operating the camera and supplemental explanations.
	This symbol indicates a reference location.
	This symbol indicates a space to use for making memos.



Using the Manual

This section explains the layout of the manual.

- **Introduction**

The introduction explains about the manual and safety precautions.

- **Chapter 1. Overview**

An overview of the product and an explanation of its features.

- **Chapter 2. Basic Operation**

An overview of the components that make up the product. This chapter also explains basic remote controller operation and a list of items that should be checked before using it.

- **Chapter 3. Recording/Playback Operations**

This chapter explains about operations related to recording and playback.

- **Chapter 4. System Settings**

This chapter explains the settings related to recording and displaying content and other detailed system settings.

- **Chapter 5. Product Specifications**

This chapter lists the product's specifications.

- **Chapter 6. Warranty**

This chapter explains the warranty.

- **Chapter 7. Contacting Photron**

This chapter lists contact information to use when contacting Photron if the product malfunctions or if a portion of the manual is unclear.

Using the Product Safely and Correctly

In order to prevent injury to yourself and others, and to prevent damage to property, carefully observe the following safety precautions.

Photron has given its full attention to the safety of this product. However, the extent of damage and injury potentially caused by ignoring the content of the safety precautions and using the product incorrectly is explained next. Please pay careful attention to the content of the safety precautions when using the product.



Warning

This symbol indicates actions that carry the risk that a person could receive a serious injury.



Caution

This symbol indicates actions that carry the risk that a person could receive a moderate injury or that damage to physical property might occur.

- The safety precautions to observe are explained with the following symbols.



This symbol indicates actions that require caution.



This symbol indicates actions that are prohibited and must be avoided.



This symbol indicates actions that must always be performed.

 **Warning**



- Do not perform actions that will damage the cable or connector.

(Do not damage the cable, modify it, use it near a heater, excessively bend, twist or pull on it, place heavy objects on it, or bundle it.)

Using the cable when damaged can cause fire, electric shock, or a short circuit.



- Do not insert metallic objects inside, or pour liquids such as water on, the product.

Doing so can cause fire, electric shock, or malfunction from short circuit or heat.



- Do not disassemble or modify the product.

There are high voltages inside the product that can cause electric shock.



- Do not plug in or unplug the power cord with wet hands.

Doing so can cause electric shock.



- Completely insert the plug until it locks into the connector.

Not fully inserting the plug can cause fire from electric shock or heat.



- When a problem occurs, immediately pull the plug from the connector on the high-speed camera.

- When a foreign substance or liquid, such as metal or water, gets inside.
- When the outer case is broken or damaged, such as from a fall.
- When the camera produces smoke, a strange smell, or strange sound.

Using the system in these conditions might cause a fire or electric shock.



Caution



- Always unplug the connector when cleaning the system or when it is unused for a long period of time.

Leaving or storing the product connected to the power source might cause fire from insulation deterioration or electrical discharge.



- Do not place the product in a location where the temperature gets unusually hot. The trunk and inside of a car can get especially hot in summer.

Doing so can cause the outer case and internal components to deteriorate or cause a fire.



- Do not place the product in a location prone to oily smoke or steam, or in a location with a lot of humidity or dust.

Oil, moisture, and dust conduct electricity, which can cause a fire or electric shock.



- Ambient temperature 0–40°C, humidity 85% RH or lower, maximum altitude 2000 m or lower, and no condensation. Using the product outside of these limits can cause malfunction.



- Do not store the product in a location where the temperature goes -20°C or lower or 60°C or higher.

Also ensure that condensation does not form.



- This product is for indoor use, do not use it outdoors.

Do not use in dusty locations. Using the product outside of these limits can cause malfunction.



- When shipping, remove the connected cable and use the original packaging or a dedicated carrying case.

Do not ship the equipment in an environment where the temperature goes -20°C or lower or 60°C or higher. Also, prevent condensation from forming during shipment.

Table of Contents

Chapter 1. Overview	1
1.1. Product Overview and Features	2
Chapter 2. Basic Operation.....	3
2.1. About the Components	4
2.1.1. Components	4
2.2. Device Connections	5
2.2.1. Connecting the Remote Controller.....	5
2.3. Remote Controller Basic Operation	6
2.3.1. Remote Controller Parts.....	6
2.3.2. Startup Screen	9
2.3.3. Displaying the Menu List.....	11
2.3.4. Menu Selection/Confirmation/Cancellation.....	12
2.3.5. Saving Recording Settings.....	13
2.3.6. Saving/Accessing Settings.....	13
2.3.7. Using Low Light Mode.....	14
Chapter 3. Recording/Playback Operations.....	15
3.1. Saving Video	16
3.2. Video Playback	19
3.3. Fast Forward & Rewind	20
3.4. Single Frame Advance.....	21
3.5. Enlarging & Shrinking the Playback Screen (Zoom, Fit, Scroll)	21
3.5.1. Screen Fit Display	22
3.5.2. Enlarge Screen (Zoom) Display.....	24
3.5.3. Scrolling the Enlarged Screen	25
3.6. Segment Playback	26
3.7. Playback Event Marker Function	27
Chapter 4. System Settings	29
4.1. Common Function Settings.....	30
4.1.1. RECORD	30
4.1.2. CALIBRATE.....	33
4.1.3. PARTITION	37
4.1.4. ADJUSTMENT	41
4.2. Network Settings.....	53

4.2.1. Setting the IP Address.....	54
4.2.2. Using DHCP (Dynamic Host Configuration Protocol).....	55
4.3. Display Settings	56
4.3.1 Switching the Date/Time Display	56
4.3.2. Show/Hide On Screen Display Text (OSD SELECT).....	57
4.3.3. Display Crosshairs	57
4.3.4. Display the R/G/B Plane (Color Models Only)	59
4.3.5. Switch the Video Signal Standard (NTSC/PAL).....	60
4.3.6. Changing the HD SDI Output Frequency	61
4.3.7. Changing the Shutter Display (SHUTTER DISPLAY).....	62
4.3.8. Individually Show/Hide On Screen Display Text (OSD CUSTOM).....	63
4.3.9. Automatically Hide Screen Text (AUTO OSD OFF).....	64
4.4. Other Detailed Settings.....	65
4.4.1. Setting the Date/Time	65
4.4.2. Post-Recording Auto-Playback Setting (AUTO PLAY)	66
4.4.3. Change Trigger Operation (RECORDING TYPE)	67
4.4.4. Reset to the Factory Default State	68
4.4.5. Loop Playback Setting (PLAYBACK TYPE).....	69
4.4.6. RESOLUTION LOCK.....	70
4.4.7. Display the System Revision	71
Chapter 5. Product Specifications	73
5.1. General Specifications	74
5.2. Dimensions	75
5.3. Equipment Diagrams	76
5.3.1. Camera Installation Bracket Equipment Diagram.....	76
5.3.2. Camera Installation Diagram.....	77
5.3.3. Strap Equipment Diagram.....	78
Chapter 6. Warranty.....	79
6.1. About the Warranty	80
Chapter 7. Contacting Photron.....	81
7.1. Contacting Photron	82



Chapter 1. Overview

1.1. Product Overview and Features

1.1. Product Overview and Features

The remote controller makes it possible to operate a high-speed camera by connecting it to the **KEYPAD** connector on the body of that camera. The remote controller is also hot-pluggable, it can be plugged into and unplugged from the camera while the power is on.



Camera connector name	Signal	Camera connector model name	Remote controller connector model name
KEYPAD	Keypad signal	PT02A-12-10S (023)	PT06A-12-10P (023)

Chapter 2. Basic Operation

2.1. About the Components

2.2. Device Connections

2.3. Remote Controller Basic Operation

2.1. About the Components

2.1.1. Components

The product's standard components are listed below. Remove the components from the packaging and check them.

1.	Remote controller unit	1
2.	Remote controller connection cable (7 m)	1
3.	Remote controller connection cable (0.5 m)	1
4.	Strap, strap bracket	1 set
5.	Camera installation bracket	1 set
6.	Remote Controller User's Manual (this manual)	1

Supplement

- "4. Strap bracket" and "5. Camera installation bracket" are packaged integrated with the remote controller.

2.2. Device Connections

2.2.1. Connecting the Remote Controller

You can operate a high-speed camera while checking a monitor by connecting the connector on the right side of the remote controller (15 pin) to the KEYPAD connector on a high-speed camera body with the included cable.



Supplement

- The photo shows an example connection to the FASTCAM BC2 HD.
- The cable connects to the connector on the right side (15 pin). The connector on the left side (9 pin) is for future expansion purposes and not currently used.
- The remote controller is hot-pluggable, it can be plugged into and unplugged from the high-speed camera while the power is on.

2.3. Remote Controller Basic Operation

The remote controller has been designed with the intention of making frequently repeated functions easily accessible. Detailed settings have also been organized in a menu which can be operated efficiently using the ARROW keys.

This section explains the basic remote controller operations necessary when recording with a high-speed camera.

2.3.1. Remote Controller Parts

- Remote controller exterior



■ Key descriptions

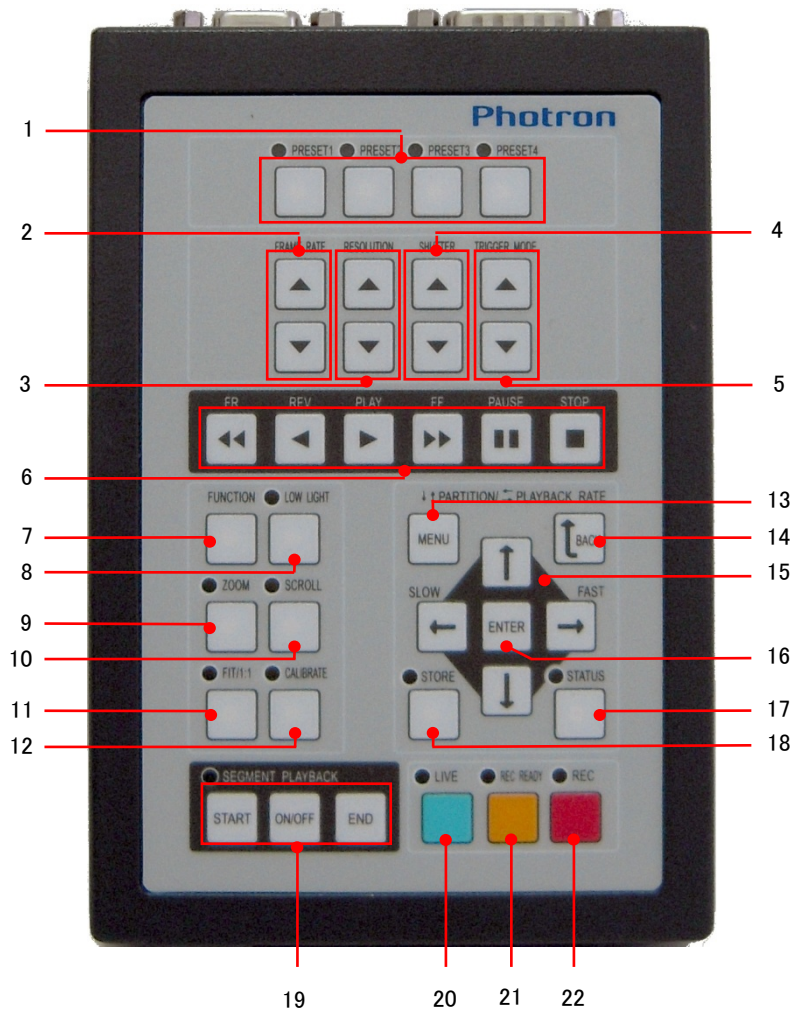

No.	Key name	Function
1	PRESET	Access preset
2	FRAME RATE	Frame rate setting
3	RESOLUTION	Resolution setting
4	SHUTTER	Shutter speed setting
5	TRIGGER MODE	Trigger mode setting
6	PLAYBACK	Playback controls
7	FUNCTION	Turns on/off the OSD display
8	LOW LIGHT	LOW LIGHT Mode
9	ZOOM	Zoom
10	SCROLL	Scroll
11	FIT/1:1	Fit monitor screen/1:1 display
12	CALIBRATE	Execute calibration
13	MENU	Menu display
14	BACK	Return from setting condition
15	↑ ↓ ← → (ARROW keys)	Move up, down, left, right
16	ENTER	Confirmation
17	STATUS	Status display
18	STORE	Store settings, store a marker
19	SEGMENT PLAYBACK	For segment playback
20	LIVE	Change LIVE/MEMORY
21	REC READY	Record ready
22	REC	Record

2.3.2. Startup Screen

- ① Refer to the hardware manual for the high-speed camera (separate manual) and finish connecting the cables, remote controller, and external devices. Then press the power switch on the high-speed camera body to turn on the power.

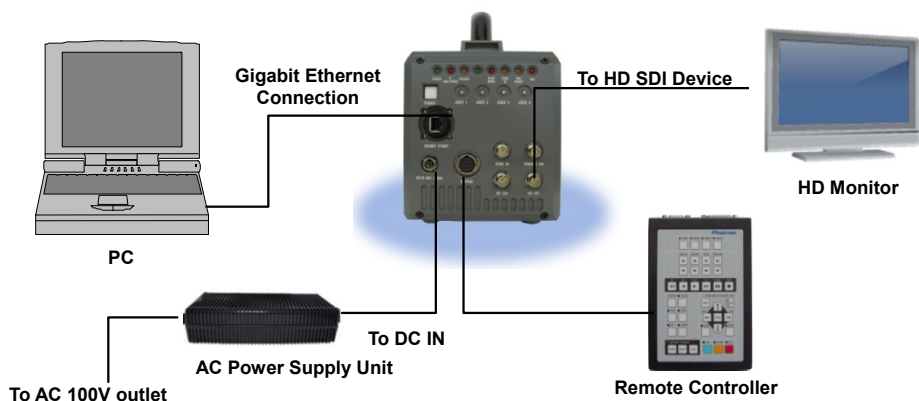

Example Cable/Device Connections

- ② After switching the power on, the current IP address setting is displayed as text in the upper-left of the LCD monitor screen.

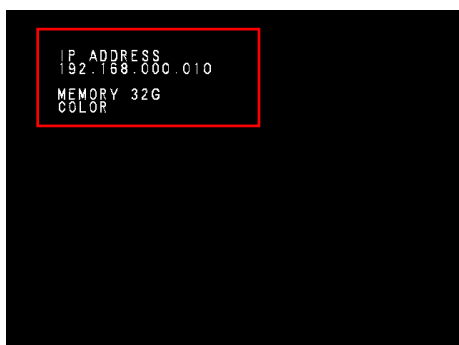

- ③ After a short time, a screen like the one shown below is displayed.
 The meaning of the text displayed on the screen is explained below.



No.	Explanation
1	Display mode (LIVE mode/MEMORY playback mode)
2	Currently used partition block/number of configured partition blocks
3	Currently set trigger mode
4	At the current setting, recordable frame count / recordable time (FR = frames, S = seconds)
5	Current frame rate (FPS = frames/second)
6	Current resolution
7	Current shutter speed (S = second)
8	Photron logo

2.3.3. Displaying the Menu List

The menu list is displayed on the LCD monitor screen by pressing the remote controller's MENU key.



Menu List Screen

To leave the menu list screen without making a selection (cancel), press the remote controller's MENU key or the BACK key.

2.3.4. Menu Selection/Confirmation/Cancellation

- ① The menu list has a hierarchical structure made up of "menu", "submenu", and "setting" layers, in that order. The cursor "►" on the menu can be moved and the necessary menu commands can be selected by pressing the remote controller's ARROW keys.
- ② The procedure for changing a setting is explained next.
- ③ Select an item on the menu using the ↑↓ (up and down) keys.

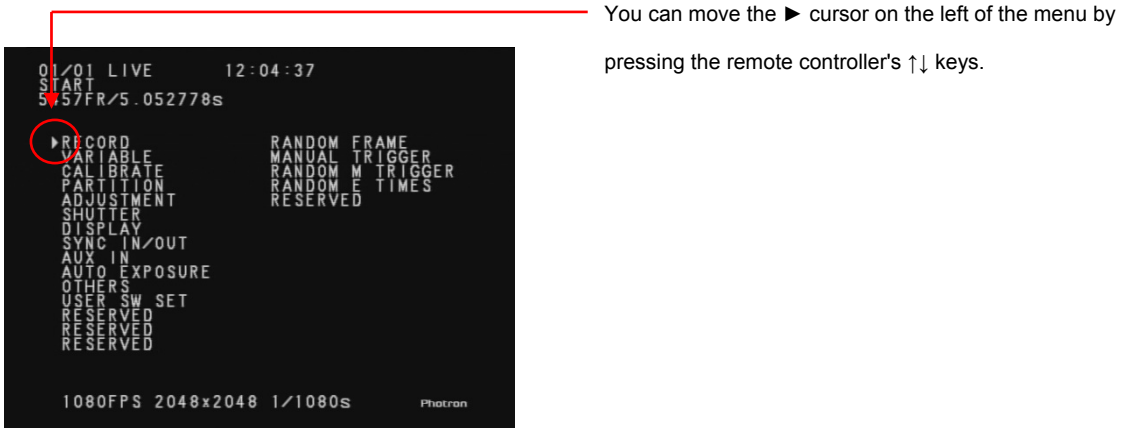

- ④ Find the item to set in the submenu and press the → (right) key to move to the submenu. To return to the menu from the submenu, press the ← (left) key.
- ⑤ Move to the item you wish to configure using the ↑↓ keys and press the ENTER key.
- ⑥ The configuration item will appear on the left side of the screen where the menu was displayed. Use the ARROW keys to change the setting. To return to the submenu from the configuration item, press the MENU key or the BACK key.
- ⑦ After changing the setting, complete your selection by pressing the ENTER key.

2.3.5. Saving Recording Settings

After using the procedure explained in "2.3.4. Menu Selection/Confirmation/Cancellation" to change settings, press the remote controller's STORE key to save the settings for the frame rate, shutter speed, and resolution, which are explained in the high-speed camera's hardware manual (separate manual). The contents of the saved settings are maintained in the high-speed camera's internal memory even when the power is turned off. However, use caution as the settings below are not saved.

- ZOOM setting
- FIT setting
- LOW LIGHT setting

The following settings are saved by switching menus regardless of explicitly saving the settings.

- MENU->OTHERS->DIGITAL I/F SET setting
- MENU->DISPLAY->NTSC/PAL setting

2.3.6. Saving/Accessing Settings

A maximum of four configuration settings can be saved. How to save/access these settings is explained next. In addition, for details on how to set recording conditions, refer to the high-speed camera's hardware manual (separate manual).

- ① On the remote controller, press the numbered PRESET key you wish to set.
- ② Configure the recording conditions. For how to configure the recording conditions, refer to the high-speed camera's hardware manual (separate manual).
- ③ Press the STORE key to save the settings. The current settings are saved to the numbered preset selected in the step one.
- ④ To access the saved settings, press the numbered PRESET key that the settings were saved to.

2.3.7. Using Low Light Mode

The more you increase the frame rate or shutter speed of the camera, the less light enters the camera making the displayed image darker. Low light mode is a function that temporarily increases the exposure time in this kind of situation, making the screen easier to see. Press the LOW LIGHT key once to turn on low light mode. Press the LOW LIGHT key once more to clear low light mode. Pressing the REC READY key automatically clears low light mode and returns you to the selected frame rate and shutter speed.

When in low light mode, "LOW LIGHT" is displayed in the lower left of the screen.



Chapter 3. Recording/Playback Operations

3.1. Saving Video

3.2. Video Playback

3.3. Fast-Forward & Rewind

3.4. Single Frame Advance

3.5. Enlarging & Shrinking the Playback Screen (Zoom, Fit, Scroll)

3.6. Segment of Interest Playback

3.7. Playback Event Marker Function

3.1. Saving Video

You can easily save video by using the remote controller.

The method differs depending on the set trigger mode.

The operations below also differ depending on the "4.4.3. Changing the Trigger Operation (RECORDING TYPE)" setting.

Reference

- For more details, see "4.4.3. Changing the Trigger Operation (RECORDING TYPE)".

- For the START trigger mode

- ① Connect the camera body and monitor and verify that the camera is in LIVE mode.

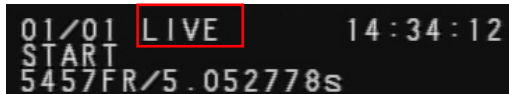

01/01 LIVE 14:34:12
START
5457FR/5.052778s

- ② Press the remote controller's REC READY key to switch to the READY state (record ready).

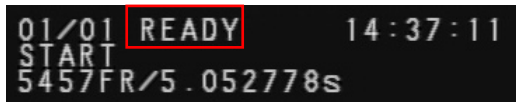

01/01 READY 14:37:11
START
5457FR/5.052778s

- ③ Press the remote controller's REC key to start recording.

If you record until the memory is full, the camera returns to the live state.



01/01 REC 14:37:32
START
5457FR/5.052778s

- For the CENTER/END/MANUAL trigger modes

- ① Connect the camera body and monitor and verify that the camera is in LIVE mode.

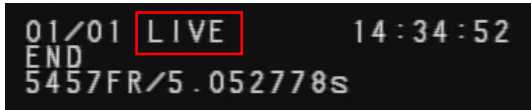

- ② Press the remote controller's REC READY key to switch to the READY state (record ready).

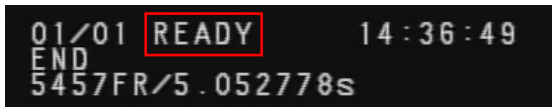

- ③ Press the remote controller's REC key to start recording.

The display shows ENDLESS and the camera continuously records video.



- ④ Press the remote controller's REC key again to end recording.

For CENTER/MANUAL, the video before and after the REC key is pressed is saved. For END, the video up until the REC key is pressed is saved.

- For the RANDOM/RANDOM RESET/RANDOM CENTER/RANDOM MANUAL trigger modes

- ① Connect the camera body and monitor and verify that the camera is in LIVE mode.

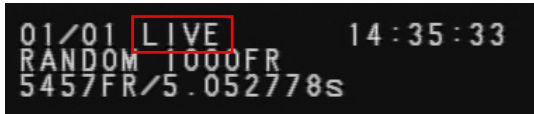

- ② Press the remote controller's REC READY key to switch to the READY state (record ready).

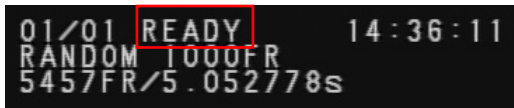

- ③ Press the remote controller's REC key to enter the recording mode.

The display shows REC. Each time the REC key is pressed the specified number of frames is saved. (In the screen below, 1000 frames are saved with each press of the button)

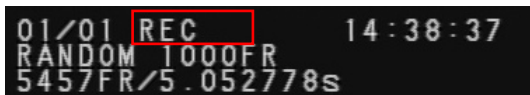

- ④ If you record until the camera's memory is full, the camera returns to LIVE mode and recording ends.

3.2. Video Playback

You can easily playback video by using the remote controller.

The method differs depending on the set trigger mode.

- ① Switch from LIVE to MEMORY mode.

If the camera is in LIVE mode, press the remote controller's LIVE key to switch to MEMORY mode. If the camera is in MEMORY mode, the LIVE key's LED is not illuminated.



You can see that the camera has transitioned to MEMORY mode when the LIVE text disappears on the monitor.

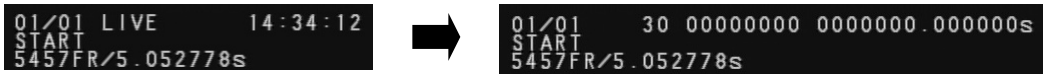

- ② Press the remote controller's PLAY key to start playback of the saved images.



The other playback control keys are listed below.

Name	Function	Explanation
FR	Fast Reverse	Plays the recorded images in fast reverse at x10, x100, x1000 of the current playback speed. The fast reverse speed is changed in order with each press of the button.
REV	Reverse	Plays the recorded images in reverse at a playback speed of 2-30 fps (NTSC), 2-25 fps (PAL).
PLAY	Play	Plays the recorded images at a playback speed of 2-30 fps (NTSC), 2-25 fps (PAL).
FF	Fast Forward	Plays the recorded images in fast forward at x10, x100, x1000 of the current playback speed. The fast forward speed is changed in order with each press of the button.
PAUSE	Pause	Pauses playback. The II symbol is displayed in the upper part of the video output screen at this time. You can advance the frame by pressing the PLAY/REV keys in this mode.
STOP	Stop	Stops playback and returns to the trigger frame.

- ③ You can change the playback speed with the remote controller's ← → keys. The current playback speed is displayed in the upper portion of the screen.

PAL Playback Rates	2, 4, 8, 12, 25 fps
NTSC Playback Rates	2, 5, 10, 15, 30 fps

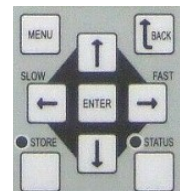

3.3. Fast Forward & Rewind

Set the camera to MEMORY mode.

- ① Press the remote controller's PLAY key.



- ② Next, you can fast-forward and rewind the video by pressing the FF key (fast forward) or FR key (rewind).



- ③ Each time you press the fast forward or rewind key, you can change the playback speed in three steps (x10, x100, x1,000).

- ④ Press the PLAY key to return to the normal playback speed. Press the PAUSE key to pause playback.



3.4. Single Frame Advance

Set the camera to MEMORY mode.

- ① Show the location in video where you wish use frame advance and press the PAUSE key to pause it.



- ② By pressing the PLAY key (playback) or REV key (reverse) in this state, you can frame advance the video one frame at a time.

You can also frame advance the video in ten frame increments by pressing the FF key (fast-forward) or FR key (rewind).

3.5. Enlarging & Shrinking the Playback Screen (Zoom, Fit, Scroll)

Photron's high-speed cameras use high-resolution sensors.

For this reason, depending on the monitor, there may be portions of the video that cannot be displayed when displayed as 1:1 video.

By also increasing the recording speed or decreasing the resolution, there are situations where the video on the screen becomes extremely small.

In these situations, use the fit function to instantly shrink/enlarge the video to an appropriate resolution for the monitor's screen.

Additionally, the image can be enlarged or shrunk by the desired zoom factor using the zoom function, making it possible to verify details or look over the entire picture.

3.5.1. Screen Fit Display

In the monitor output, the size of video at different resolutions is adjusted to fill the screen. The following section explains an example where a 512x128 pixel video is fit to a NTSC monitor.

Caution

- The FASTCAM BC2 HD does not have a NTSC output function. Only HD SDI output is available.

- ① Press the remote controller's FIT/1:1 key.

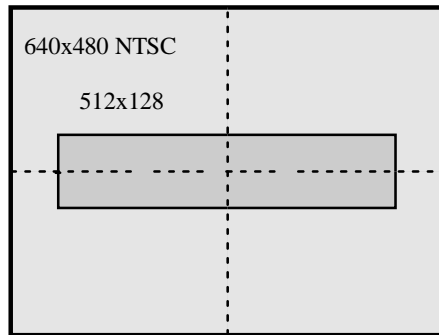
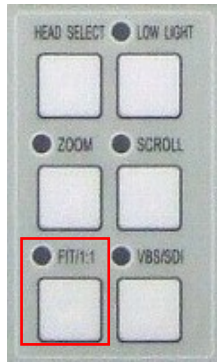

- ② The monitor screen's display size changes and the recording area is displayed at its maximum size on the screen.

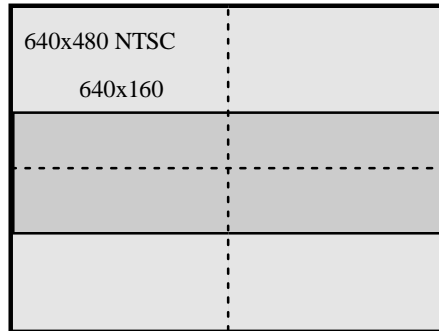

-
- ③ Press the FIT/1:1 key again to return to the original size.

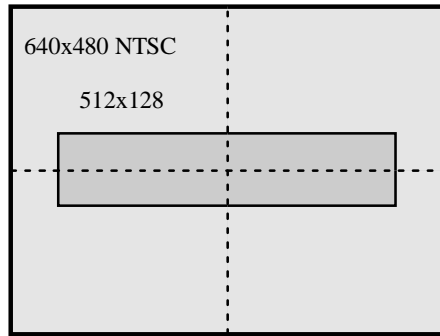
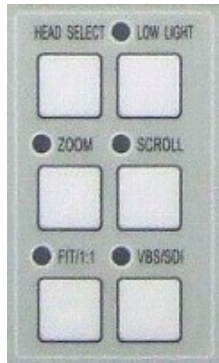

3.5.2. Enlarge Screen (Zoom) Display

This function displays the monitor output image enlarged (zoomed).

- ① Press the remote controller's ZOOM key.

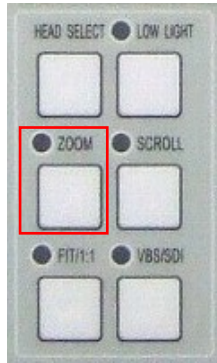

- ② The LED for the remote controller's ZOOM key illuminates. The ZOOM message and current zoom factor are also displayed on the monitor screen.



- ③ Enlarge or shrink the display with the up and down ARROW keys. The function maintains the center of the screen while zooming.

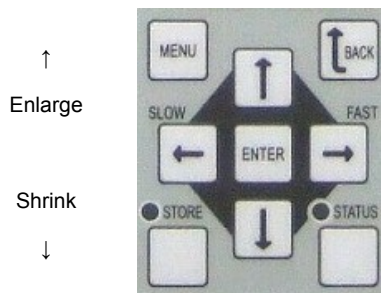

3.5.3. Scrolling the Enlarged Screen

You can scroll to and display the desired location of an image that has been enlarged in the previous section.

- ① Press the remote controller's SCROLL key.

The LED for the SCROLL key illuminates.

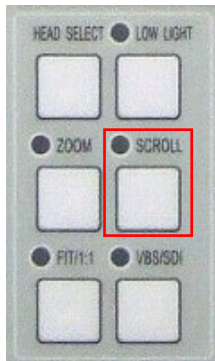

- ② The SCROLL message is displayed in the upper right of the monitor screen.



- ③ Scroll the screen with the ARROW keys.

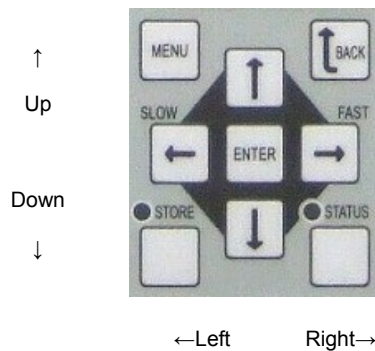

3.6. Segment Playback

The playback of images recorded at high-speed takes an extraordinary long time. For example, one second of high-speed video recorded at 2000 fps takes 66 seconds to playback at the normal 30 fps, in other words, over one minute of playback time. In many cases, the range of images you wish to view is only a few images out of the 2000 recorded.

Photron high-speed cameras have the segment playback function to playback only the range of images you wish to view by simply specifying the start and stop points of that range.

This section explains how to use the segment playback.

- ① Set the camera to MEMORY mode.
- ② Playback the video using the normal procedure.



- ③ Press the START key at the start point of the range of images you wish to view.



- ④ Press the END key at the end point of the range of images you wish to view.



- ⑤ Press the ON/OFF key in the remote controller's SEGMENT PLAY BACK section and check that the LED is illuminated. This puts the camera in segment playback mode.



Playback operations will now occur only within the range specified by the start and end points.

3.7. Playback Event Marker Function

In MEMORY mode, you can store 10 playback image frame numbers and immediately access, or jump to, those stored frame numbers (event marker frames). By marking the locations you wish to view while the video is playing, you can easily recall those locations with this convenient function.

- ① Set the camera to MEMORY mode.
- ② Playback the video using the normal procedure.
- ③ Display the frame to store and press the STORE key.

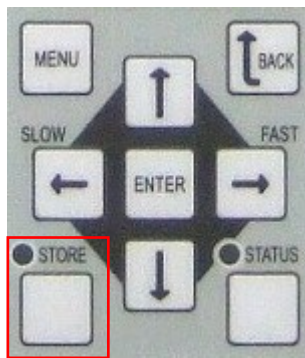

- ④ Repeat steps 2 and 3 above. You can store a total of 10 points.
- ⑤ You can jump to the event marker frames using the up and down SHUTTER keys (▲▼).



When an event marker frame is displayed, "**MARKER FRAME x**" appears in the screen text.
(Where x is a number from 1-10)

! Caution

- When storing a frame that exceeds the 10th point, the points are overwritten from the first stored frame number.



Chapter 4. System Settings

4.1. Function Settings

4.2. Network Settings

4.3. Display Settings

4.4. Other Detailed Settings

4.1. Common Function Settings

You can configure the many functions related to recording with the product by pressing the MENU key. This section explains the function settings shared between camera models.

4.1.1. RECORD

This item configures the camera operation when using a specific trigger.

This setting has items like the ones shown below.



■ RANDOM FRAME

To use the RANDOM trigger, the number of frames to save each time the trigger is input must be set in advance before recording. For the RANDOM trigger's operation, refer to the "Selecting the Trigger Mode" section of the camera's hardware manual.

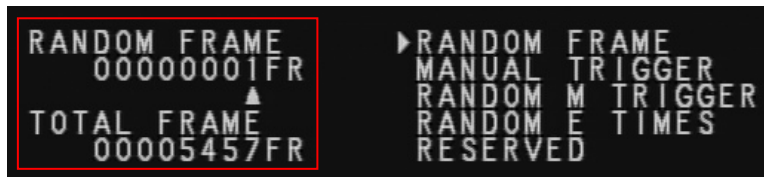

• RANDOM FRAME

Sets the number of frames to record for each trigger. You can enter a value of TOTAL FRAME or lower.

For example, by entering "1000FR",

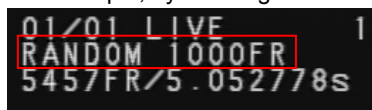

"RANDOM 1000FR" is displayed on the screen. This indicates that 1,000 frames worth of images are recorded for each trigger input.

■ MANUAL TRIGGER

To use the MANUAL trigger, you must set the number of frames to record before the trigger input. For the MANUAL trigger's operation, refer to the "Selecting the Trigger Mode" section of the camera's hardware manual (separate manual).

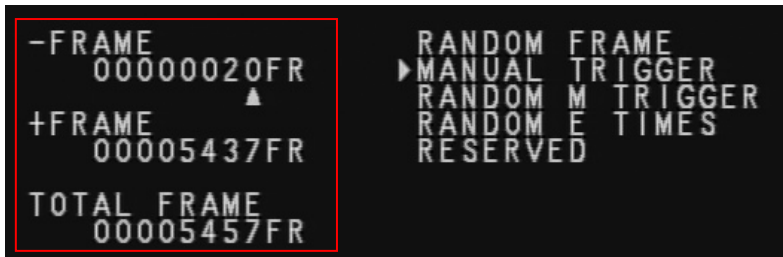

• -FRAME

Sets the number of frames to record before the trigger input.

The settable range is 0 to "TOTAL FRAME".

For example, by entering "1000FR",

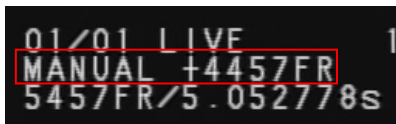

"MANUAL +4457FR" is displayed on the screen. This is the +FRAME value which is the -FRAME value subtracted from TOTAL FRAME.

• +FRAME

Shows the number of frames to record after the trigger input.

Only -FRAME can be set.

• TOTAL FRAME

Shows the total recordable frames according to the memory capacity and resolution of the currently used camera.

■RANDOM M TRIGGER

To use the RANDOM MANUAL trigger, you must set the number of frames to record before and after the trigger input. For the RANDOM MANUAL trigger's operation, refer to the "Selecting the Trigger Mode" section of the camera's hardware manual (separate manual).

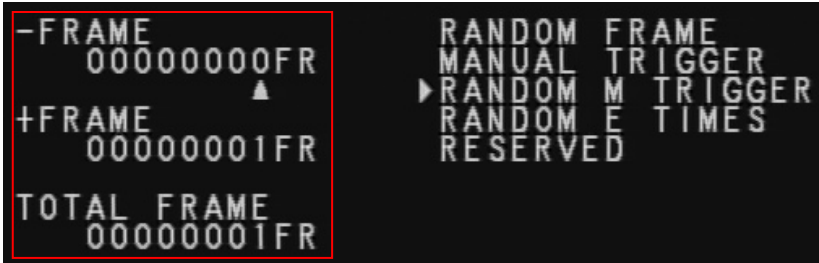

- -FRAME

Sets the number of frames to record before the trigger input.

- +FRAME

Sets the number of frames to record after the trigger input.

- TOTAL FRAME

Different than the RANDOM and MANUAL triggers, this does not show the total number of recordable frames, it shows the total of -FRAME and +FRAME.

■RANDOM E TIMES

When using the RANDOM CENTER and RANDOM MANUAL triggers, you can set how many times to record. For the detailed operation, refer to the "Selecting the Trigger Mode" section of the camera's hardware manual (separate manual).



- RANDOM E TIMES

Enter the number of times to record.

4.1.2. CALIBRATE

The CALIBRATE item can calibrate the camera.

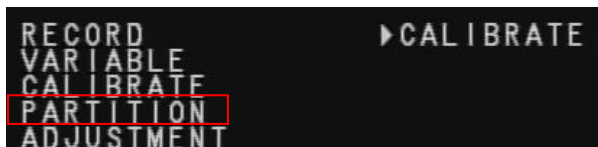

■ Execute calibration

The procedure for executing calibration is explained below.

- ① Set the FRAME RATE and SHUTTER with the remote controller's $\uparrow\downarrow$ keys.
- ② Shield the lens using the lens cap. Since the black image at this time will be used as the correction reference, verify that the lens is completely shielded and that no light is leaking into the sensor.
- ③ Press the remote controller's MENU key to display the menu.
- ④ Using the remote controller's ARROW keys, select the CALIBRATE menu, then select the CALIBRATE menu from the submenu.

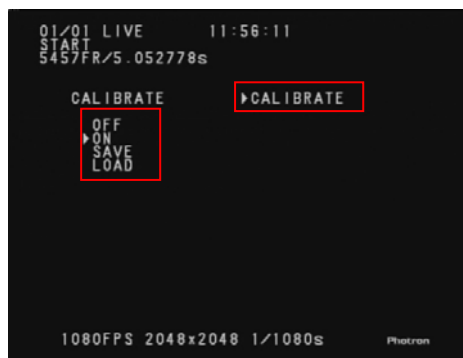
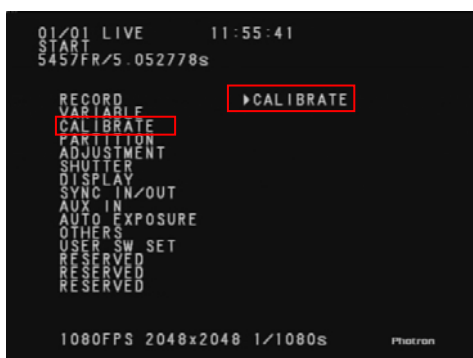

- ⑤ With the remote controller's $\uparrow\downarrow$ keys, move to ON, verify that the lens is shielded and then press the remote controller's ENTER key.
- ⑥ Calibration finishes executing with the operation above.
- ⑦ Remove the lens cap and verify that the image is displayed correctly.

You can also easily calibrate the camera with the remote controller's CALIBRATE key.

- ① Press the remote controller's CALIBRATE key. The menu is displayed on screen.
- ② Calibration finishes executing when the CALIBRATE key is pressed again.



Supplement

● In order to obtain faithful image output, it is highly recommended to execute calibration before recording when the following settings are changed.

- When the frame rate is changed
- When the shutter speed is changed
- When the resolution is changed

Also, depending on the settings, phenomena such as the following may occur.

- Fixed noise like horizontal bands appears
- A portion of the screen is clear, but noise appears in the area around it

These phenomena can be resolved by executing calibration again.

■ Saving calibration settings

The black image data for correction use that was obtained by executing the calibration can be saved as one pattern internally on the camera. The procedure for doing this is explained below.

- ① Press the remote controller's MENU key to display the menu.
- ② Use the remote controller's $\uparrow\downarrow$ keys to select the CALIBRATE menu.
- ③ Press the remote controller's ENTER key to select the item.
- ④ Select the SAVE item with the remote controller's $\uparrow\downarrow$ keys, then press the ENTER key to save.

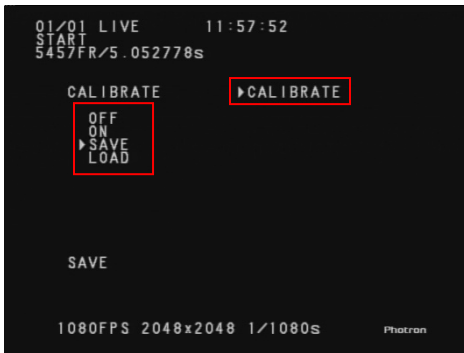

Supplement

- The save process can take from tens of seconds to a few minutes.

■ Loading calibration settings

- ① Press the remote controller's MENU key to display the menu.
- ② Use the remote controller's $\uparrow\downarrow$ keys to select the CALIBRATE menu.
- ③ Press the remote controller's ENTER key to select the item.
- ④ Select the LOAD item with the remote controller's $\uparrow\downarrow$ keys, then press the ENTER key.
- ⑤ The saved black image data for correction is loaded from internal memory and the output image reflects the correction.

■ Calibration mode option

Only the corresponding model can change the calibration method.

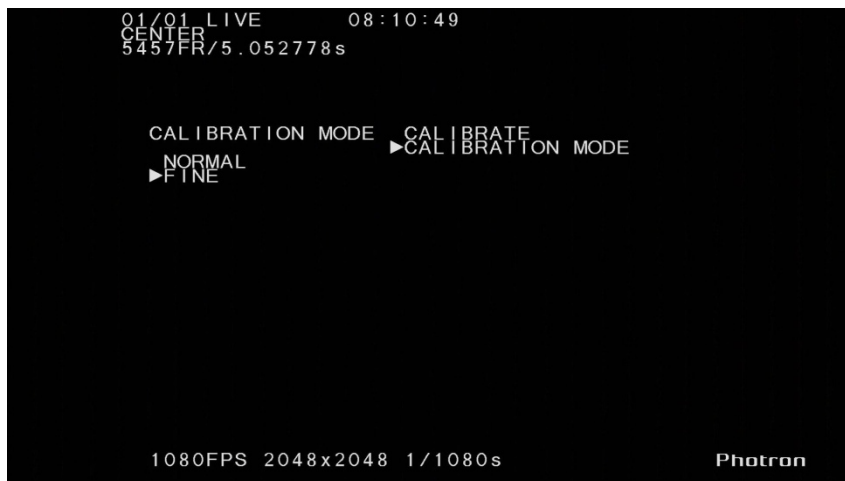

NORMAL : Calibrate using a normal method.

FINE : Calibrate using a fine method.

4.1.3. PARTITION

This item configures camera operation when recording with partitioned memory.

This setting has items like the ones shown below.



■ Memory partition setup

To use memory partitions, you must setup in advance how the memory will be partitioned before recording. The procedure for configuring these settings is explained here.

- ① Press the remote controller's MENU key to display the menu list.
- ② Select PARTITION SETUP from the PARTITION submenu with the remote controller's ARROW keys and press the ENTER key.



- ③ A message to confirm whether or not to configure partitions is displayed. To configure partitions, select YES. The setup menu is displayed.

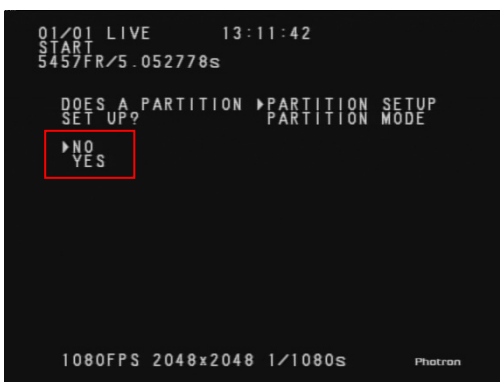

- ④ Select the number of partitions with the remote controller's ARROW keys. When finished, press the ENTER key to complete the setting.

* Verify that the ID display on the screen has changed to the fraction display.

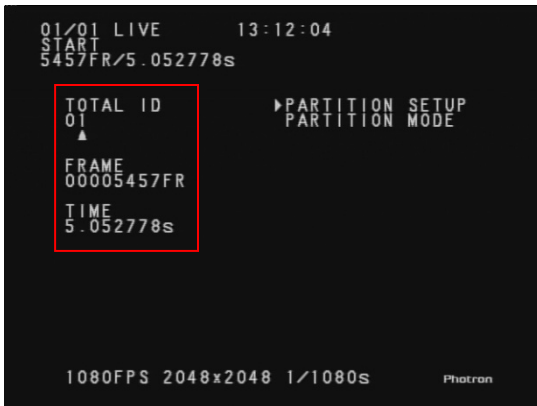

■ Recording to a partitioned section

This section explains how to record in memory partition mode.

- ① Verify that the camera is in LIVE mode.
- ② Select the section ID you wish to record to with the remote controller's ARROW keys. Verify the ID display on the screen.

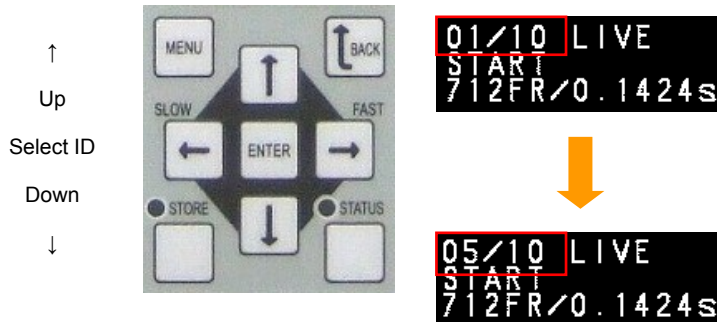

- ③ When the section ID you wish to record to is set, record following the normal recording procedure.

■ Recorded section playback

The images recorded to each partitioned section can be played by selecting the section ID.

- ① Verify that the camera is in MEMORY mode.
- ② Select the section ID you wish to play with the remote controller's ARROW keys. Verify the ID display on the screen.

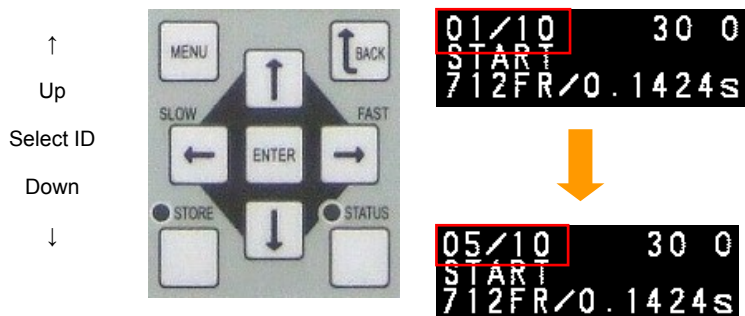

- ③ When the section ID you wish to play is set, play it following the normal playback procedure.

■ PARTITION MODE

You can configure the recording setting in memory partition mode. ◦

There are two modes: MODE1 and MODE2.



MODE1 : " Recording to a partitioned section" operation as previously explained (p. 38).

MODE2 : After recording, automatically moves to the next partition.

• **The section below shows the operation when the partition count is 10 in MODE2.**

- ① Put the camera in the READY state with ID01.
- ② Input the REC trigger to record.
- ③ After recording ends, the ID automatically changes to 02 and the camera waits for the REC trigger input.

This means in START mode, the camera is in the READY state. In CENTER, END, and MANUAL modes, the camera is in the ENDLESS state.

- ④ Input the REC trigger to start recording.
- ⑤ Recording ends.
- ⑥ The ID automatically changes to 03 and the camera waits for the REC trigger input.
- ⑦ Steps ②, ③, and ④ are repeated, recording finishes with ID10, and then the camera returns to LIVE.

This mode saves the effort of moving to an ID manually and putting the camera into the trigger wait state, so it is better suited for consecutive recordings while changing IDs.

Supplement

- MODE2 operation is only valid when the trigger mode is the following modes.
START, CENTER, END, MANUAL

4.1.4. ADJUSTMENT

This item configures the white balance adjustment, color enhancement function, LUT (look-up table) operation, and edge enhancement function.

This setting has items like the ones shown below.



■ COLOR TEMP (color models only)

Color models have the white balance adjustment setting. Two methods are available for adjusting the white balance, preset and user-editable white balance.

• Using preset white balance

There are two types of white balance presets (5100K, 3100K) for use with common light sources. The suggested color temperature for these presets is listed below.

5100K (daylight, outdoors)

3100K (halogen light source)

- ① Press the remote controller's MENU key to display the menu list.
- ② Select COLOR TEMP from the ADJUSTMENT submenu with the remote controller's ARROW keys and press the ENTER key.



- ③ Select 5100K (or 3100K) and press the ENTER key.
- ④ Verify that the white balance has changed on the screen.

• Using user white balance

User white balance can be set in order to achieve the most appropriate white balance for the light source used and the conditions during recording.

The values set here are stored in the camera's internal memory as the user preset, and they can be loaded by selecting USER.

There are also two methods for setting user white balance, AUTO USER and EDIT USER. Each of these methods is explained here.

■ Configuring white balance with AUTO USER

- ① Set the desired conditions (frame rate, shutter speed, resolution) for recording.
- ② Press the remote controller's MENU key to display the menu list.
- ③ Select COLOR TEMP from the ADJUSTMENT submenu with the remote controller's ARROW keys and press the ENTER key.

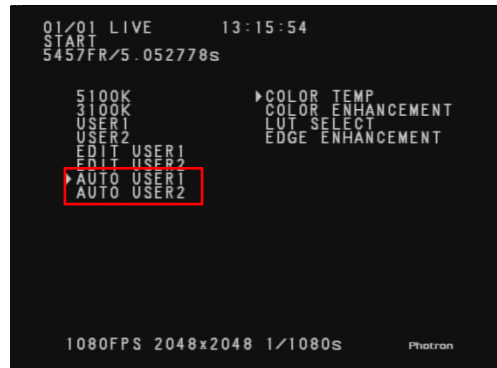
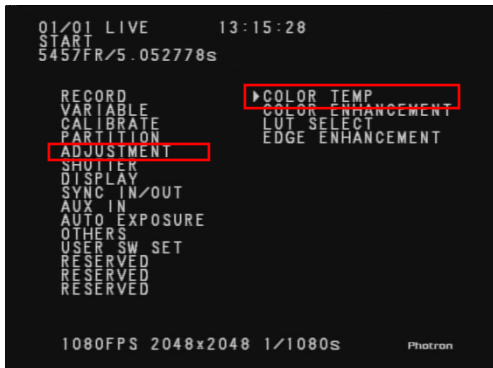

- ④ Select AUTO USER1 or AUTO USER2 and press the ENTER key to start the white balance adjustment mode.
- ⑤ Verify that a value similar to that shown below is displayed at the bottom left of the screen.



- ⑥ Turn on the lighting to be used for recording, and in the center of the screen, show an object, such as white paper, to be the white reference.
- ⑦ Adjust the lens aperture and the light intensity. Verify that the value at the bottom left of the screen changes with the intensity of the light entering the camera. If the brightness on the screen changes but the display does not, verify that the white reference object is shown in the middle of the screen.

- ⑧ Adjust the light intensity if DARK is displayed in the lower left of the screen until it changes to PUSH ENTER KEY. If the light intensity is too bright, BRIGHT is displayed. Reduce the light intensity.



- ⑨ Press the remote controller's ENTER key when PUSH ENTER KEY is shown.
- ⑩ The camera acquires the appropriate white balance value with this operation. Verify that the display image has been adjusted.
- ⑪ The set value can be loaded by selecting USER1 or USER2.



Supplement

- AUTO USER1 is saved in USER1. AUTO USER2 is saved in USER2.

■ Configuring white balance with EDIT USER

The white balance can be set automatically, and the user can also adjust the tint by changing the RGB values. The value acquired by AUTO USER1 or AUTO USER2 can also undergo fine adjustment. This section explains how to configure the white balance using EDIT USER1 or EDIT USER2.

- ① Set the desired conditions (frame rate, shutter speed, resolution) for recording.
- ② Press the remote controller's MENU key to display the menu list.
- ③ Select COLOR TEMP from the ADJUSTMENT submenu with the remote controller's ARROW keys and press the ENTER key.

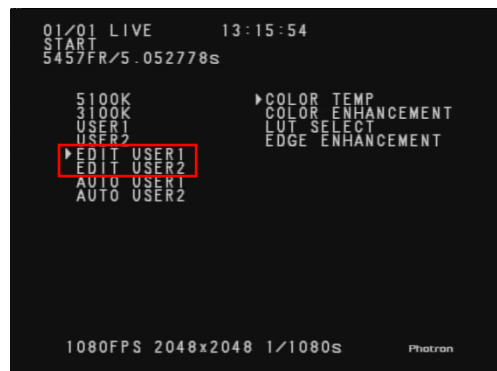
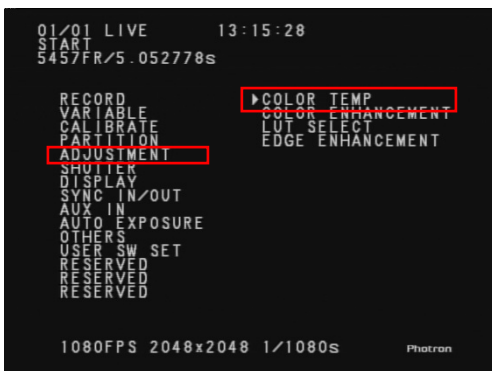

- ④ Select EDIT USER1 or EDIT USER2 and press the ENTER key. The white balance adjustment items are displayed.
- ⑤ Use the ARROW keys to set the RGB values. Press the ENTER key to confirm the settings when finished.



- ⑥ The set value can be loaded by selecting USER1 or USER2.

Supplement

- EDIT USER1 is saved in USER1. EDIT USER2 is saved in USER2.

■ COLOR ENHANCEMENT (color models only)

Color models have a color enhancement setting. The color enhancement level can be adjusted in five steps, including OFF.

- ① Press the remote controller's MENU key, select COLOR ENHANCEMENT from the ADJUSTMENT submenu and press the ENTER key.

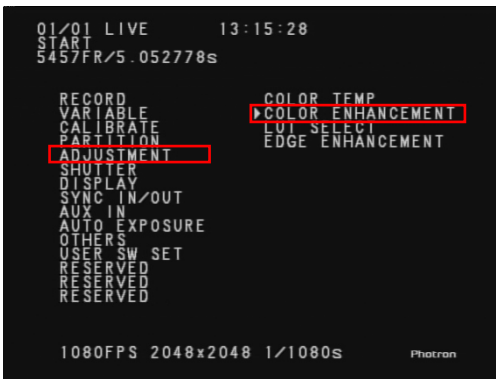

- ② The settings are displayed. Each setting is described in the chart below.



Menu display	Explanation
OFF	Turns color enhancement mode off
LEVEL 1	Sets x0.5 color enhancement
LEVEL2	Sets x1 (default) color enhancement
LEVEL3	Sets x1.5 color enhancement
LEVEL4	Sets x2 color enhancement

- ③ Use the remote controller's $\uparrow\downarrow$ keys to select one of the modes listed above. When finished, press the ENTER key to complete the setting.

■ LUT SELECT

- Using preset LUT patterns

Nine preset LUT patterns have been prepared in advance on the camera. This section explains about each of these patterns.

- ① Press the remote controller's MENU key to display the menu list.
- ② Select LUT SELECT from the ADJUSTMENT submenu with the remote controller's ARROW keys and press the ENTER key.

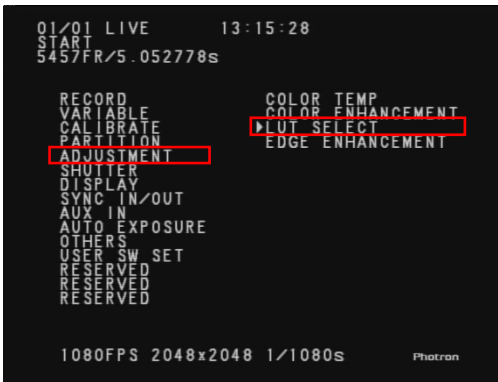

- ③ Select D1 through D9 and that LUT setting is loaded.

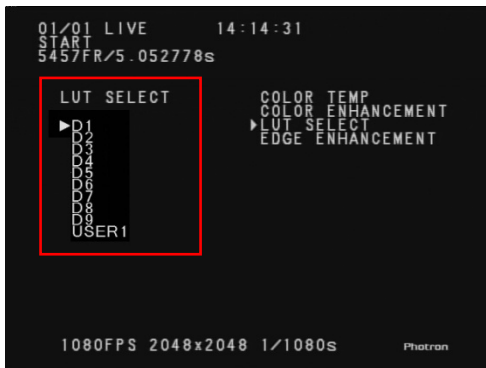

D1: Gain 1x

The input is always linear output. This LUT is used for normal conditions.

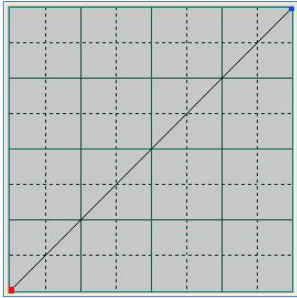

D2: Gain 2x

The gain is doubled and you can display the dark areas of the image emphasized.

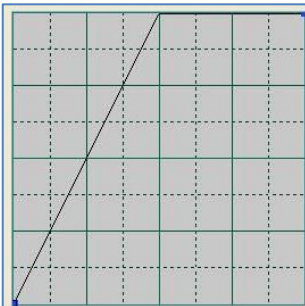

D3: Gain 4x

The gain is quadrupled and you can display the dark areas of the image emphasized. This LUT emphasizes the dark portions even more than D2.

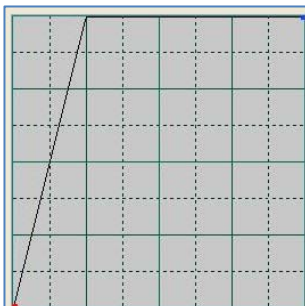

D4: Gamma 0.56

This LUT is 0.56 gamma correction. The optimum Gamma for a MAC monitor.

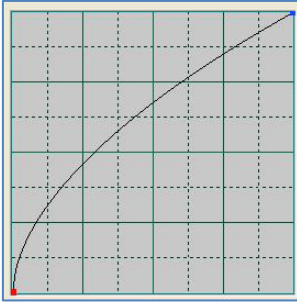

D5: Gamma 0.56 Gain 2x

This LUT is double gain at 0.56 gamma correction.

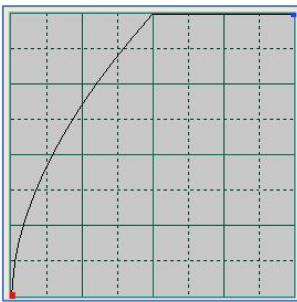

D6: Gamma 0.56 Gain 4x

This LUT is quadruple gain at 0.56 gamma correction

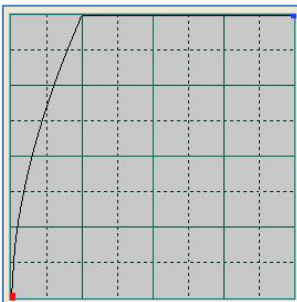

D7: Gamma 0.45

This LUT is 0.45 gamma correction. The optimum Gamma for a video monitor.

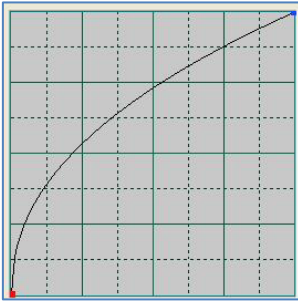

D8: Gamma 0.45 Gain 2x

This LUT is double gain at 0.45 gamma correction

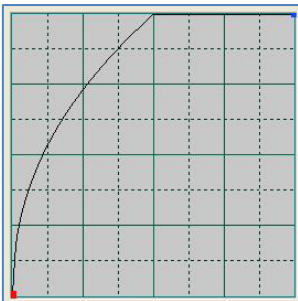

D9: Gamma 0.45 Gain 4x

This LUT is quadruple gain at 0.45 gamma correction.

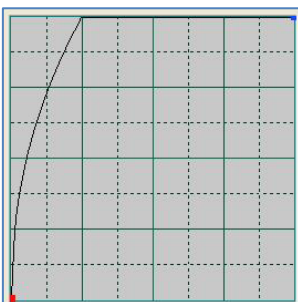

- **Using a custom LUT**

Creating a LUT pattern is done with PFV. For details, refer to the "Photron FASTCAM Viewer User's Manual".

- **About USER1**

Select USER1 to use the custom LUT created with PFV.

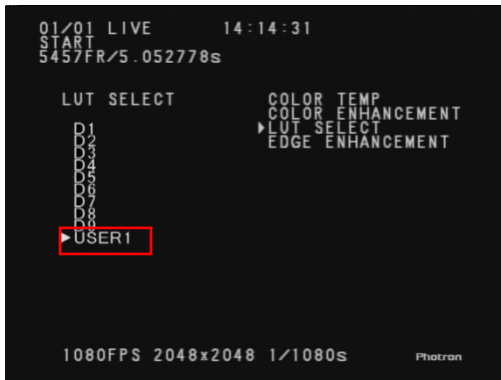

■ EDGE ENHANCEMENT

You can enhance the edges of images in three steps with the camera's edge enhancement setting.

- ① Press the remote controller's MENU key, select EDGE ENHANCEMENT from the ADJUSTMENT submenu and press the ENTER key.

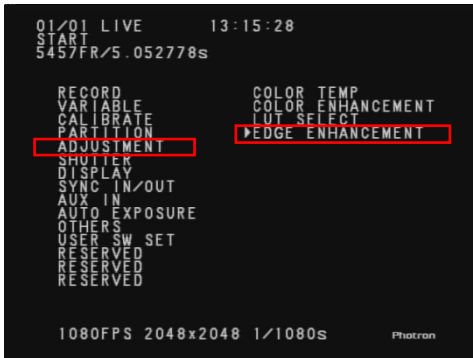

- ② The settings are displayed. Each setting is described in the chart below.

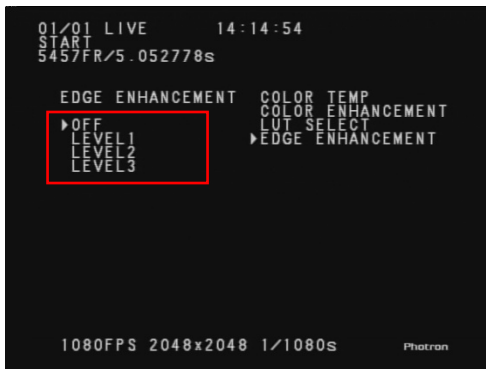

Menu display	Explanation
OFF	Edge enhancement off.
LEVEL1	Edge enhancement set to weak.
LEVEL2	Edge enhancement set to medium.
LEVEL3	Edge enhancement set to strong.

- ③ Use the remote controller's ARROW keys to select one of the modes listed above. When finished, press the ENTER key to complete the setting.

■ BLACK ADJ LEVEL

For this product, eight stages to adjust the black level can be set.

- ① Press the remote controller's MENU key, select BLACK ADJ LEVEL from the ADJUSTMENT submenu and press the ENTER key.

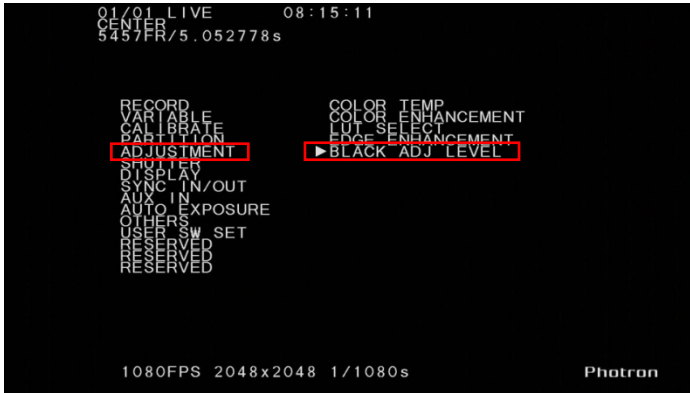

- ② The setting are displayed. Each setting is described in the chart below.

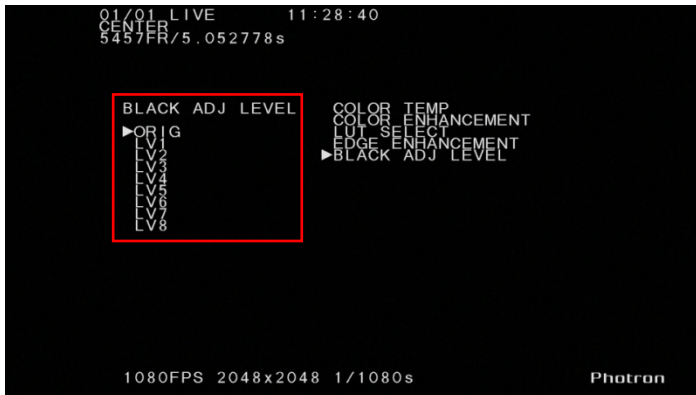

- ③ Use the remote controller's ARROW keys to select one of the modes listed above. When finished, press the ENTER key to complete the setting.

4.2. Network Settings

Photron high-speed cameras can be controlled from a PC using the Gigabit Ethernet interface. For how to operate the Photron FASTCAM Viewer software, refer to the "Photron FASTCAM Viewer User's Manual".

This section explains the required network settings when connecting a high-speed camera to a PC.

Supplement

- The default values of the high-speed camera's network settings are listed below.

IP ADDRESS > 192.168.0.10

NETMASK > 255.255.255.0

GATEWAY ADDRESS > 0.0.0.0

PORT > 2000 (fixed, not changeable)

4.2.1. Setting the IP Address

This section shows how to set the high-speed camera's IP address.

■ Configuration procedure

- ① Press the remote controller's MENU key to display the menu list.
- ② Select DIGITAL I/F SET from the OTHERS submenu with the remote controller's ARROW keys and press the ENTER key.

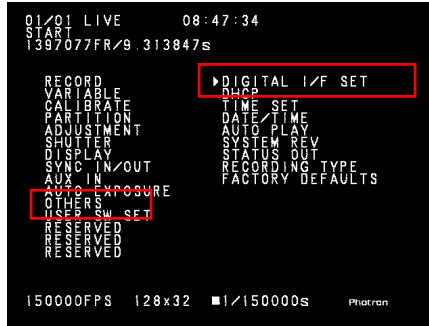

- ③ Use the ARROW ←→ keys to move between digits and the ↑↓ keys to set the IP address.

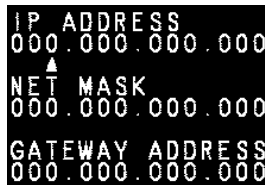

- ④ Press the ENTER key to confirm.

Caution

- When connecting the Gigabit Ethernet interface compatible Photron cameras to a PC, set each of those devices to a different IP address. When connecting to an existing network, do not use IP addresses that are already in use on the network.

4.2.2. Using DHCP (Dynamic Host Configuration Protocol)

Photron high-speed cameras are DHCP compatible. In an environment where DHCP is used, the high-speed camera's IP address can be acquired from the DHCP server.

■ Configuration procedure

- ① Press the remote controller's MENU key to display the menu list.
- ② Select DHCP from the OTHERS submenu with the remote controller's ARROW keys and press the ENTER key.

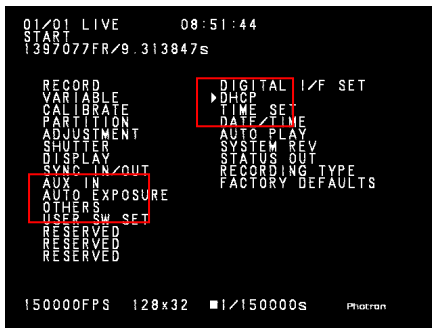

- ③ Select ON/OFF with the ARROW keys.



- ④ Press the ENTER key to confirm.

- When OFF is selected, the IP address specified in the previous section "4.2.1. Setting the IP Address" is valid.
- When ON is selected, the IP address is acquired from the DHCP server and that acquired IP address is valid. If the camera is not connected to a DHCP server, the IP address is acquired when a connection is made to the server. You can verify the acquired IP address with the DIGITAL I/F SET menu. In this situation, the IP address cannot be changed.
- When using the camera with DHCP on, set the IP address in PFV to "Auto detection".

Reference

- For details, refer to the "Photron FASTCAM Viewer User's Manual".

4.3. Display Settings

Photron high-speed cameras display many types of information about recording on the monitor. This section explains about the display settings for displaying information on the monitor.

4.3.1 Switching the Date/Time Display

You can select either the date or time be displayed on the screen. The procedure to display them is explained here.

- ① Press the remote controller's MENU key to display the menu list.
- ② Select DATE/TIME from the OTHERS submenu with the remote controller's ARROW keys and press the ENTER key.
- ③ The DATE/TIME menu is displayed.

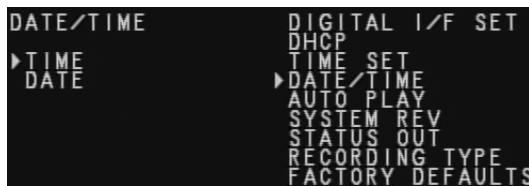

- ④ Select DATE or TIME with the $\uparrow\downarrow$ keys. The selected option is displayed on the screen.
- ⑤ When the setting is complete, press the ENTER key to finish.
- ⑥ Verify that the date or the time is displayed on the screen according to the setting.

Date Display Setting



Time Display Setting

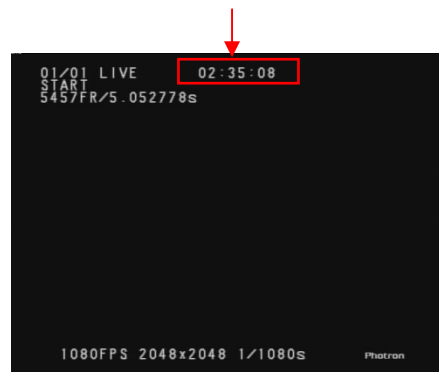

4.3.2. Show/Hide On Screen Display Text (OSD SELECT)

- ① Press the remote controller's MENU key to display the menu list.
- ② Select OSD SELECT from the DISPLAY submenu with the remote controller's ARROW keys and press the ENTER key.



- ③ Select ON/OFF with the ARROW keys. When ON, text on the screen is displayed. When OFF, text is not displayed on the screen.

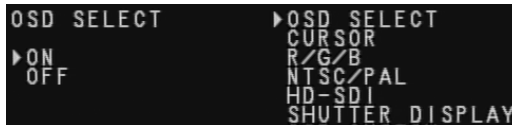

- ④ When the setting is complete, press the ENTER key to finish.
- ⑤ Verify that the screen's text display is ON or OFF.

You can also change the display with a single button by pressing the FUNCTION key.

4.3.3. Display Crosshairs

Displays crosshairs (a reference line or reticule) on the LCD monitor screen. The crosshairs can be used to determine the position of an object within the image or as an aid when viewing video playback.

- ① Press the remote controller's MENU key to display the menu list.
- ② Select CURSOR from the DISPLAY submenu with the remote controller's ARROW keys and press the ENTER key.

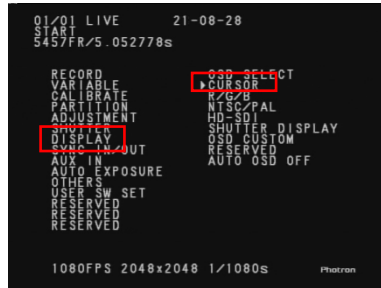

- ③ Select either OFF, ON1, or ON2 with the remote controller's $\uparrow\downarrow$ keys and press the ENTER key. Two types of cursors are provided, one with white lines (ON1) and black lines (ON2).

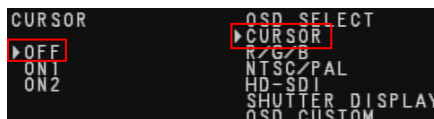

- ④ When ON is selected, the crosshairs (reticule) reference lines are displayed on the screen. At the same time, the coordinates of the center point of the crosshairs are displayed on the screen.
- ⑤ The reference line can be moved to any position using the remote controller's ARROW keys.

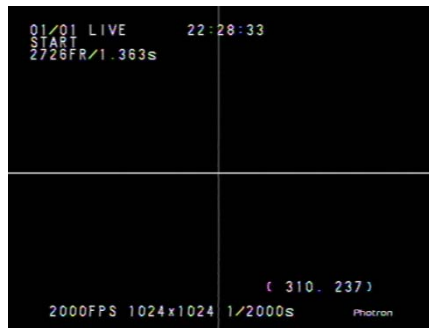

Caution

- Be aware that the cursor's coordinates are the coordinates for the VIDEO output screen display, not the coordinates of the actual image data.

For NTSC (VIDEO/SDI) output: X=0 to 639, Y=0 to 479

For PAL (VIDEO/SDI) output: X=0 to 759, Y=0 to 569

For HD SDI output: X=0 to 1919, Y=0 to 1079

4.3.4. Display the R/G/B Plane (Color Models Only)

- ① Press the remote controller's MENU key to display the menu list.
- ② Select R/G/B from the DISPLAY submenu with the remote controller's ARROW keys and press the ENTER key.



- ③ Select the R/G/B plane to be displayed, or all of the RGB planes, with the remote controller's $\uparrow\downarrow$ keys. Press the ENTER key to complete the setting.

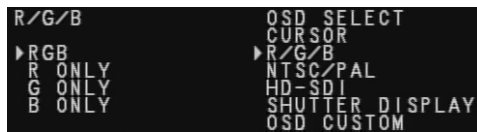

4.3.5. Switch the Video Signal Standard (NTSC/PAL)

Select the high-speed camera's video output signal format. You can select the format from NTSC or PAL.

- ① Press the remote controller's MENU key to display the menu list.
- ② Select NTSC/PAL from the DISPLAY submenu with the remote controller's ARROW keys and press the ENTER key.

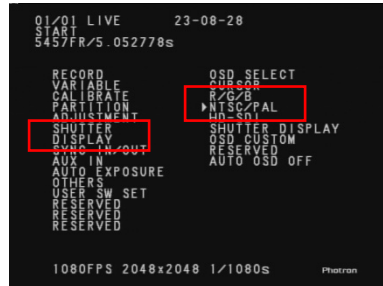

- ③ Select NTSC or PAL with the remote controller's $\uparrow\downarrow$ keys and press the ENTER key.



- ④ Cycle the power on the high-speed camera to enable the setting. The video output format changes and the camera starts up.

Supplement

- The frequencies that can be set with HD SDI output change depending on the NTSC/PAL setting. For details, see "4.3.6. Changing the HD SDI Output Frequency".

4.3.6. Changing the HD SDI Output Frequency

You can change the HD SDI output frequency. The frequencies that can be set differ depending on whether the video signal format is NTSC or PAL.

- ① Press the remote controller's MENU key to display the menu list.
- ② Select HD-SDI from the DISPLAY submenu with the remote controller's ARROW keys and press the ENTER key.

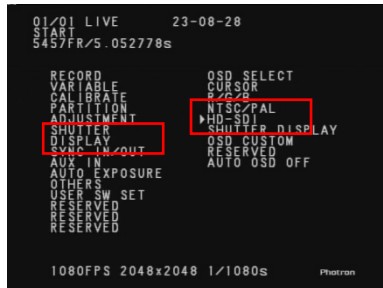

- ③ Select desired item with the remote controller's ↑↓ keys and press the ENTER key.

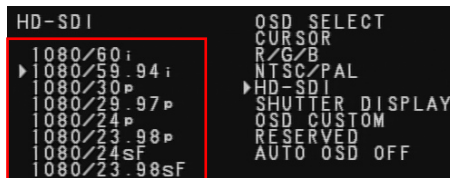

- ④ Cycle the power on the high-speed camera to enable the setting. The HD SDI output frequency changes and the camera starts up.

Supplement

- Configurable output frequencies

NTSC: 60i , 59.94i , 30p , 29.97p , 24p , 23.98p , 24p(sF) , 23.98p(sF)

PAL: 50i , 25p , 24p , 23.98p , 24p(sF) , 23.98p(sF)

4.3.7. Changing the Shutter Display (SHUTTER DISPLAY)

The OSD shutter display can be switched between 1/xxxx s and 0.000000s.

For precision, the 1/xxxx s display is numerically cleaner looking (for example 1/1000 s, 1/3000 s), whereas the 0.000000s display is accurate.

- ① Press the remote controller's MENU key to display the menu list.
- ② Select SHUTTER DISPLAY from the DISPLAY submenu with the remote controller's ARROW keys and press the ENTER key.



- ③ Select 1/xxxS or 0.xxxS with the remote controller's $\uparrow\downarrow$ keys and press the ENTER key.

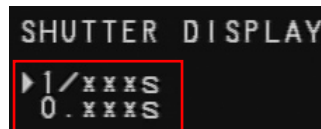

- ④ The display format for the LCD monitor is changed.

4.3.8. Individually Show/Hide On Screen Display Text (OSD CUSTOM)

You can turn the entire on screen display ON/OFF with OSD SELECT, but with OSD CUSTOM you can individually turn the on screen display elements ON/OFF.

- ① Press the remote controller's MENU key to display the menu list.
- ② Select OSD CUSTOM from the DISPLAY submenu with the remote controller's ARROW keys and press the ENTER key.

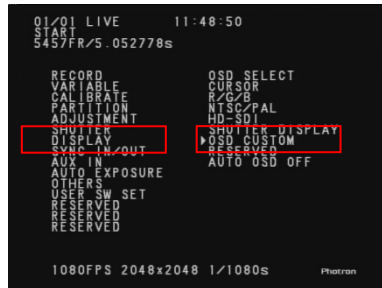

- ③ With the remote controller's $\uparrow\downarrow$ keys, select the item and show/hide with the $\leftarrow\rightarrow$ keys.
- ④ Items with the \blacksquare symbol are displayed.

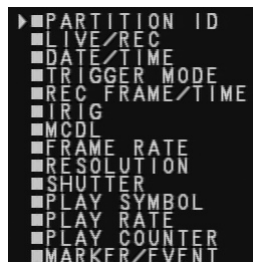

- ⑤ The display items are changed.

4.3.9. Automatically Hide Screen Text (AUTO OSD OFF)

The on screen display can be turned on/off with OSD SELECT, but with AUTO OSD OFF, the on screen display is automatically turned off during MEMORY data playback.

- ① Press the remote controller's MENU key to display the menu list.
- ② Select AUTO OSD OFF from the DISPLAY submenu with the remote controller's ARROW keys and press the ENTER key.

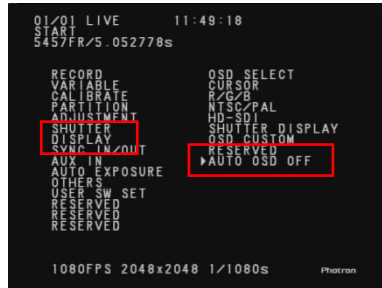

- ③ Select ON/OFF with the ARROW keys. When ON is selected, the text is not displayed on the screen in MEMORY mode.



- ④ When the setting is complete, press the ENTER key to finish.
- ⑤ Verify that the screen's text display is ON or OFF in MEMORY mode.

4.4. Other Detailed Settings

4.4.1. Setting the Date/Time

This option sets the high-speed camera's internal clock. Set the date and time so it can be added as data to the recorded image. Once the date/time is set, the values are saved even when the system power is turned off.

- ① Press the remote controller's MENU key to display the menu list.
- ② Select TIME SET from the OTHERS submenu with the remote controller's ARROW keys and press the ENTER key.
- ③ The TIME SET settings are displayed on the left of the screen.

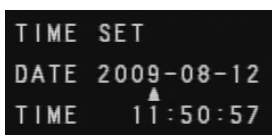

- ④ You can move to the item with the ←→ keys and change the setting's value with the ↑↓ keys.

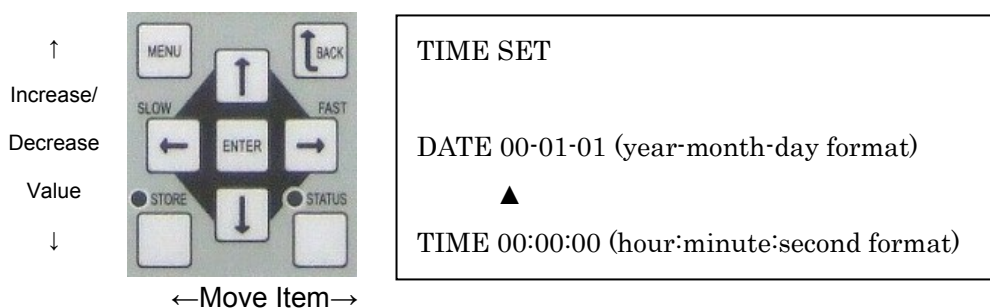

- ⑤ When all the settings are complete, press the ENTER key to finish.

4.4.2. Post-Recording Auto-Playback Setting (AUTO PLAY)

The high-speed camera is equipped with a mode that automatically switches the system from LIVE mode to MEMORY (playback) mode, displays the trigger frame and pauses playback immediately after recording is finished. You can use this mode by setting AUTO PLAY to ON. This function is convenient for immediately verifying the recorded video after recording.

- ① Press the remote controller's MENU key to display the menu list.
- ② Select AUTO PLAY from the OTHERS submenu with the remote controller's ARROW keys.

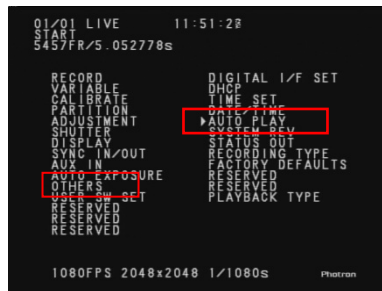

- ③ The menu to select the AUTO PLAY format ON/OFF is displayed on the left side of the screen.



- ④ Select ON/OFF with the remote controller's $\uparrow\downarrow$ keys. Press the ENTER key, then the MENU key to close the menu list. The setting is complete.
- ⑤ In LIVE mode, perform a recording operation and verify that the system automatically switches to MEMORY mode after recording.

4.4.3. Change Trigger Operation (RECORDING TYPE)

Normally for recording, the READY key is input and the high-speed camera is put in the READY state, then the REC trigger is input and the recording operation is performed. However, by setting the high-speed camera to direct trigger mode, the recording operation can be performed without the READY key input.

In this way, you can reduce a step in the operation of the system.

- ① Press the remote controller's MENU key to display the menu list.
- ② Select RECORDING TYPE from the OTHERS submenu with the remote controller's ARROW keys.

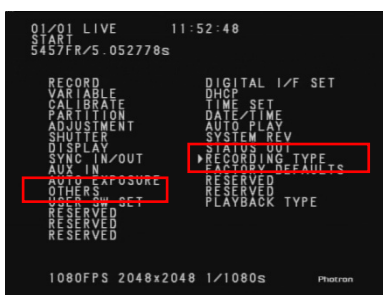

- ③ Select either READY AND TRIG or DIRECT TRIG on the menu.

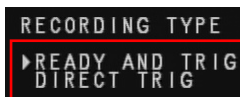

- ④ Press the ENTER key to confirm.

■ The operation of the high-speed camera for each item is shown below.

- **READY AND TRIG**

READY key input is always necessary before the REC trigger.

(READY AND TRIG is the initial setting)

- **DIRECT TRIG**

The recording operation can be performed with just the REC trigger, without the READY key input.

- The operation of the high-speed camera for each trigger mode is shown below.
[] indicates the high-speed camera's operations, "trigger" indicates the REC trigger input.

- **START, RANDOM**

[LIVE] → "trigger" → [READY] → "trigger" → [REC]

- **CENTER, END, MANUAL**

[LIVE] → "trigger" → [ENDLESS] → "trigger" → [REC]

4.4.4. Reset to the Factory Default State

You can reset the high-speed camera's settings (frame rate, resolution, menu settings, etc.) to the factory default state.

- ① Press the remote controller's MENU key to display the menu list.
- ② Move to the FACTORY DEFAULTS item from the OTHERS submenu with the remote controller's ARROW keys and press the ENTER key.



- ③ Select CANCEL or RESET with the remote controller's ↑↓ keys. CANCEL cancels the reset operation. RESET executes the system reset.

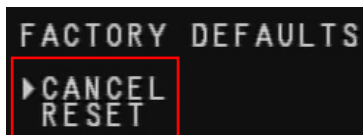

- ④ Press the ENTER key to confirm.

4.4.5. Loop Playback Setting (PLAYBACK TYPE)

With this item you can set whether or not to playback video in a loop when playing recorded data in MEMORY mode. Loop playback is on by default.

- ① Press the remote controller's MENU key to display the menu list.
- ② Select PLAYBACK TYPE from the OTHERS submenu with the remote controller's ARROW keys.



- ③ The menu to select the PLAYBACK TYPE format ON/OFF is displayed on the left side of the screen.

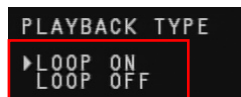

- ④ Select ON/OFF with the remote controller's ↑↓ keys. Press the ENTER key, then the MENU key to close the menu list. The setting is complete.
- ⑤ Verify the loop playback operation by playing video in MEMORY mode.

4.4.6. RESOLUTION LOCK

Generally, a max resolution under respective FPS will be set automatically when the FPS is changed. Under the circumstance of using a Resolution Lock function, the speed can be changed while resolution is fixed to a certain value.

- ① Press the remote controller's MENU key to display the menu list.
- ② Select RESOLUTION LOCK from the OTHERS submenu with the remote controller's ARROW keys.

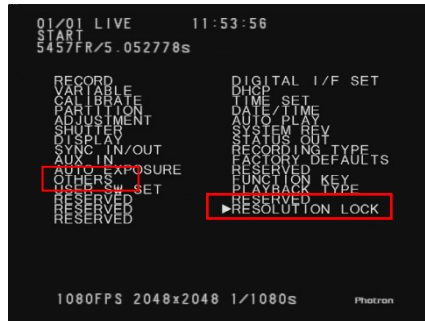

- ③ The menu to select the RESOLUTION LOCK format ON/OFF is displayed on the left side of the screen.



- ④ Select ON/OFF with the remote controller's ↑↓ keys. Press the ENTER key, then the MENU key to close the menu list. The setting is complete.

4.4.7. Display the System Revision

This option displays the system revision on the high-speed camera being used.

- ① Press the remote controller's MENU key to display the menu list.
- ② Select SYSTEM REV from the OTHERS submenu with the remote controller's ARROW keys and press the ENTER key.



- ③ The system revision of the high-speed camera currently being used is displayed.

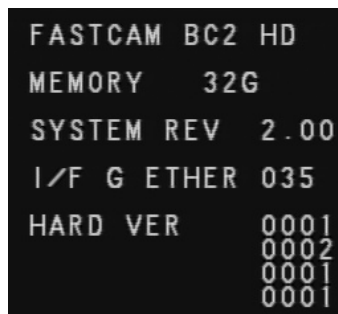

The high-speed camera model name, memory capacity, system revision, I/F version, and hardware version is displayed.

Supplement

- The image above and the revision version may differ depending on when the camera was shipped.



Chapter 5. Product Specifications

5.1. General Specifications

5.2. Dimensions

5.3. Equipment Diagrams

5.1. General Specifications

Environment conditions	
Storage temperature	-20°C to 60°C (no condensation)
Storage humidity	85% or less (no condensation)
Guaranteed operating temperature	0°C to 40°C (no condensation)
Guaranteed operating humidity	85% or less (no condensation)
External dimensions	
Remote controller unit	155.4 (H) x 105.4 (W) x 28.1 (D) mm, excluding protrusions
Weight	
Remote controller unit only	460 g
Unit + 7 m cable	1.15 kg
Unit + 0.5 m cable	620 g

5.2. Dimensions

(mm)

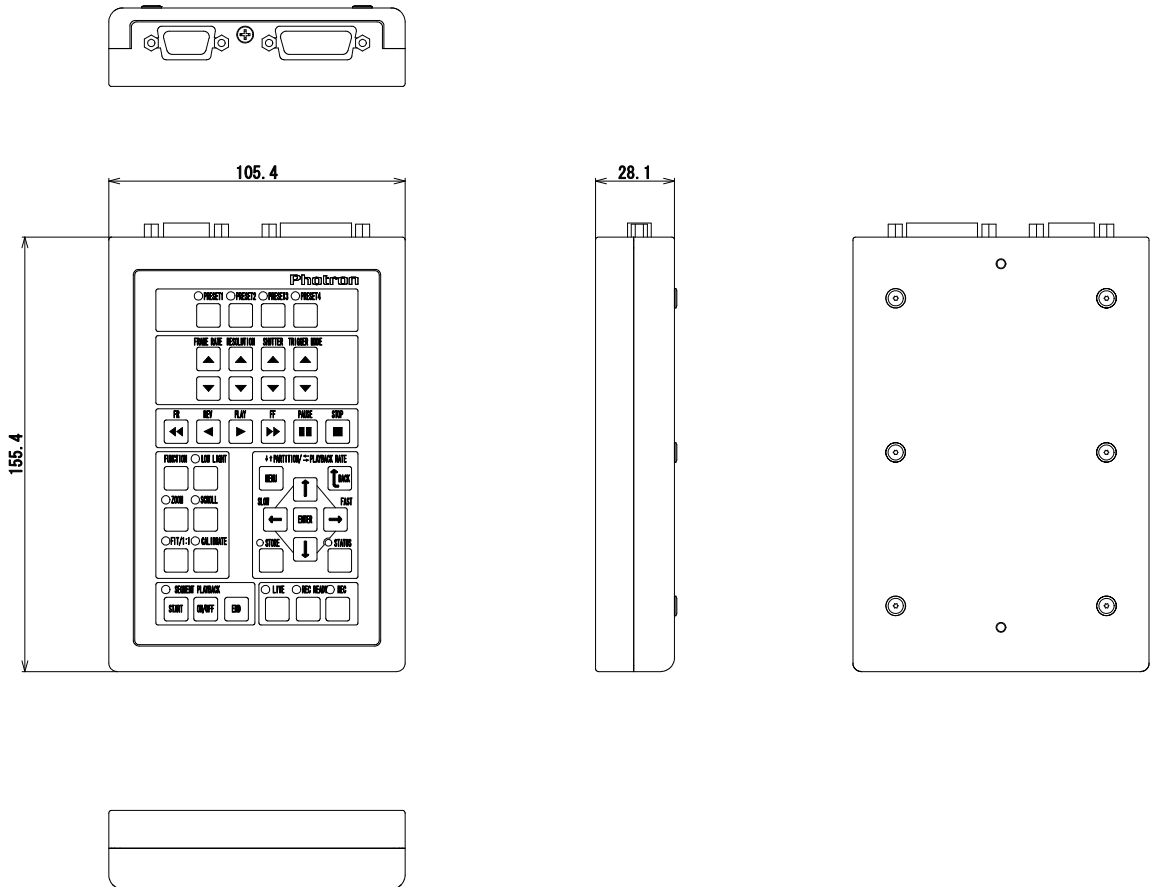

5.3. Equipment Diagrams

5.3.1. Camera Installation Bracket Equipment Diagram

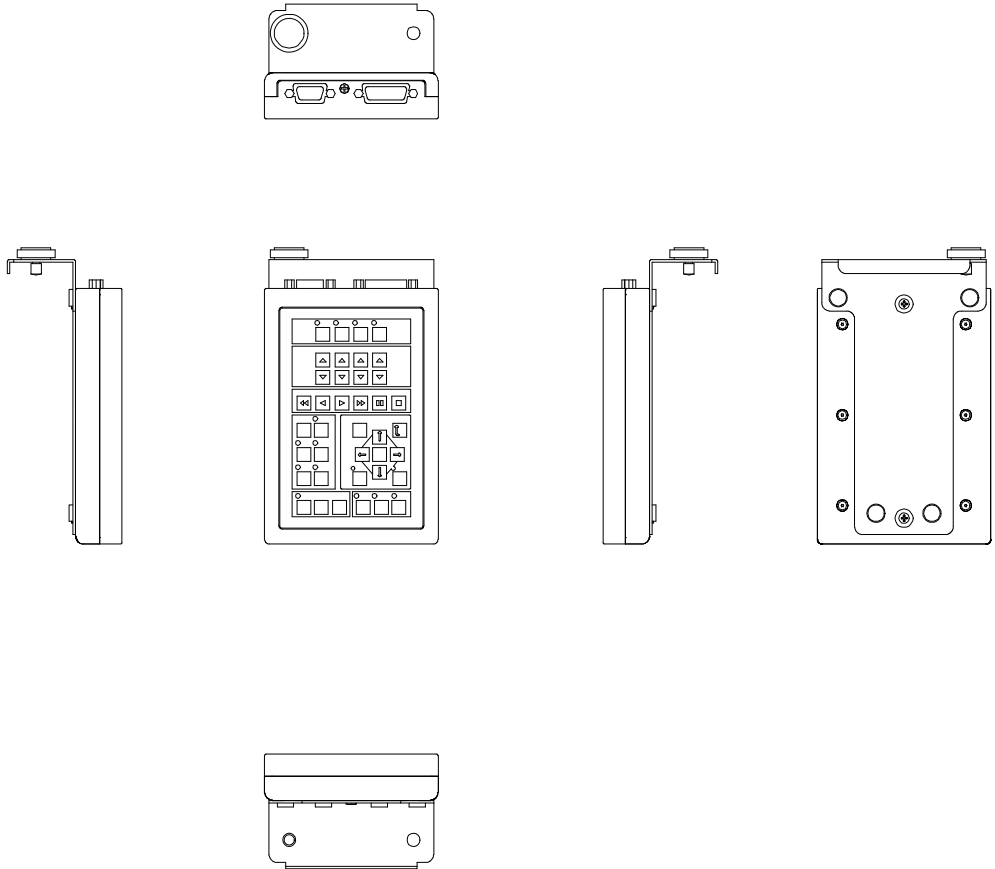

5.3.2. Camera Installation Diagram

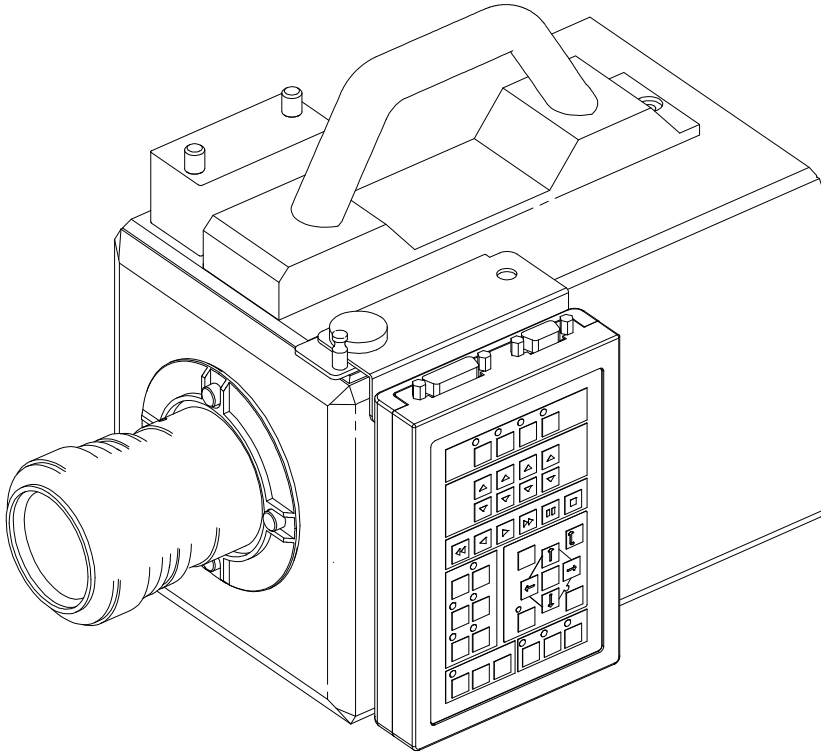

5.3.3. Strap Equipment Diagram

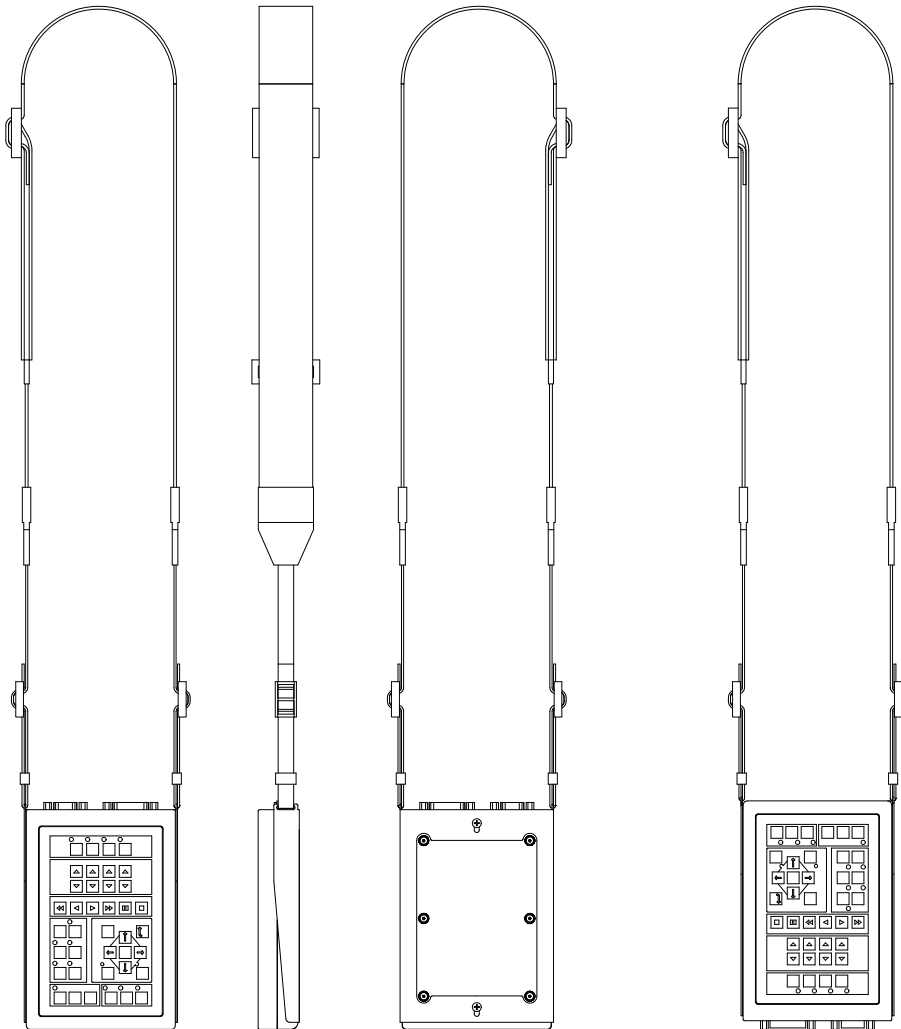

Equipped with Connector Up

Equipped with Connector Down

Chapter 6. Warranty

6.1. About the Warranty

6.1. About the Warranty

This system has been shipped having undergone testing. However, in the unlikely event that it malfunctions due to a manufacturing defect, it will be repaired, at no charge, within the warranty period.

■ Warranty Exceptions

The following exceptions will result in fee-based repair, even within the warranty period.

- ① Damage or malfunction as a result of fire, earthquake, water damage, lightning, other natural disasters, pollution, or the effects of abnormal voltage.
- ② Damage or malfunction as a result of dropping or mishandling during shipment or when moving after purchase or misuse.
- ③ Consumable goods (cables)
- ④ When repair, adjustment, or alternation done by an entity other than Photron service has been performed on the system, or damage or malfunction that is determined to be attributed to a fault in the use the product.

Reference

- For inquires related to malfunction, contact the dealer where the product was purchased or Photron (see 7.1. Contacting Photron).

Chapter 7. Contacting Photron

7.1. Contacting Photron

7.1. Contacting Photron

For technical inquiries related to the product, or for inquiries related to the user's manual, telephone, FAX, or e-mail Photron using the contact information listed below.

When calling, please ensure that you have dialed the correct number.

Additionally, the following items will be verified when inquiring, so please ready them in advance.

Items	Example
Contact information	Company name, customer name, telephone number, etc.
Product name	Remote Controller
Serial number	Check on the nameplate sticker.
Reason of inquiry	System condition or what you know about it

Contact Information	
In Americas and Antipodes	<p>PHOTRON USA, INC. 9520 Padgett Street, Suite 110 San Diego, CA 92126-4446, USA Phone : 800-585-2129 or 858-684-3555 Fax : 858-684-3558 E-mail : image@photron.com www.photron.com</p>
In Europe, Africa and India	<p>PHOTRON EUROPE LIMITED The Barn, Bottom Road, West Wycombe, Buckinghamshire, HP14 4BS, U.K. Phone : +44(0) 1494 48 1011 Fax : +44(0) 1494 48 7011 E-mail : image@photron.com www.photron.com</p>
In other areas	<p>PHOTRON LIMITED Fujimi 1-1-8, Chiyoda-Ku Tokyo 102-0071, Japan Phone : +81 3 3238 2105 Fax : +81 3 3238 2147 E-mail : digital@photron.co.jp www.photron.co.jp</p>

Remote Controller

User's Manual Revision 1.02E

Publication Date March, 2011

Publisher PHOTRON LIMITED

Chiyoda Fujimi Bldg., Fujimi 1-1-8, Chiyoda-ku, Tokyo 102-0071,
JAPAN